



Quicktron

We Move The Future

 www.quicktron.com  info@quicktron.com     @Quicktron Robotics

Driving Intralogistics Automation with Intelligent Robotic Solutions

R&D Initiatives

400+

R&D
Specialists

500+

Patents
Applications

Industry Leader

1500+

Clients

20+

Countries

20+

Industries

1000+

Max AMRs for a
single warehouse

28,000+

Global Robot
Deployments

Founded in 2014, Quicktron™ accelerates intralogistics automation using intelligent robotic solutions. We design and manufacture future-proof mobile robots and provide a variety of automation solutions. Our robots meet the highest quality and safety standards, equipped with advanced sensors that enable them to navigate complex environments and perform a variety of tasks, including storing, picking, packing, and transporting goods.

We help businesses liberate human workers from mundane and repetitive tasks in warehouses and factories while optimizing order fulfillment and production efficiency across various industries. With over 25,000 operational robotic units deployed worldwide, Quicktron™ is a trusted partner for businesses of all sizes. Quicktron™ employs 1000+ talents and invests 60% budget in research and development in pursuits of innovation. This commitment to technical advancement enables us to offer industry-specific automation solutions that address the supply chain challenges of both today and tomorrow.

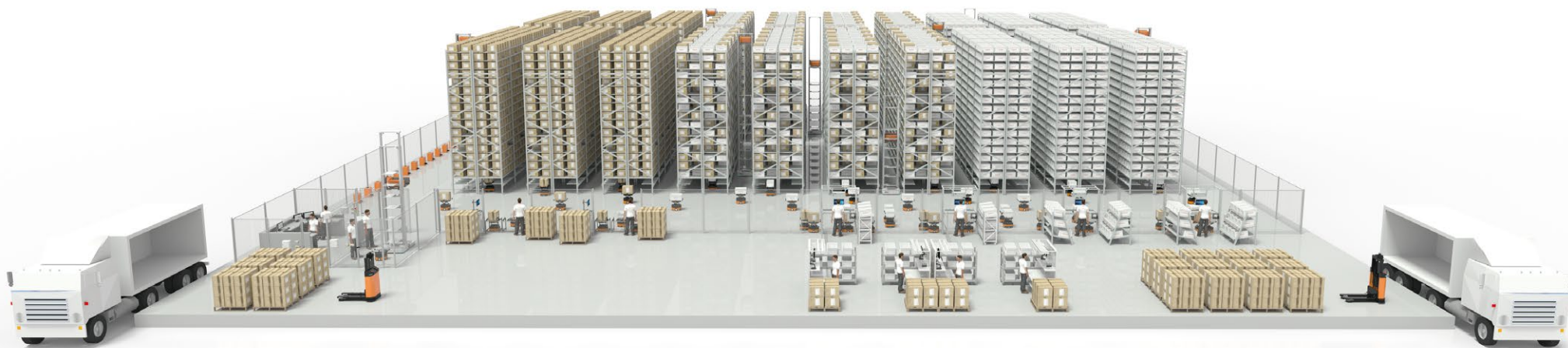

2014	Quicktron establishment Angel round	1st generation robots launched	Implemented the intelligent robotic warehouse solution for Paul Frank
2015	Series A funding		Completed intelligent warehouses for BEST and Vip.com
2016		2nd generation robots launched	Large scale applications delivered in China
2017	Series B funding	ISO9001/CR certification	Automated warehouse in APAC
2018	Series C funding		First warehouse with 1000+ AMRs for Cainiao in Asia
2019		Quicktron system 2.0 released 3rd Generation robots launched CE certification	National Key engineering project "AI innovation and development"
2020	Series C+ funding		Strategic partnership with KION and its subsidiaries Linde and DEMATIC to expand business overseas
2021		4th Generation robots launched	Set up subsidiaries in Seoul, Tokyo, Singapore and Frankfurt for local projects execution
2022		25,000 robots delivered	Set up subsidiaries in LA, Madrid and Birmingham for local projects execution
2023		Launched Quicktron System 3.0 Introduced Hybrid Intralogistics Automation Solutions	Set up a subsidiary in Texas, USA Forged strong partnerships in Europe, Asia, USA and ANZ regions.



Funding



Product



Development

Global footprint

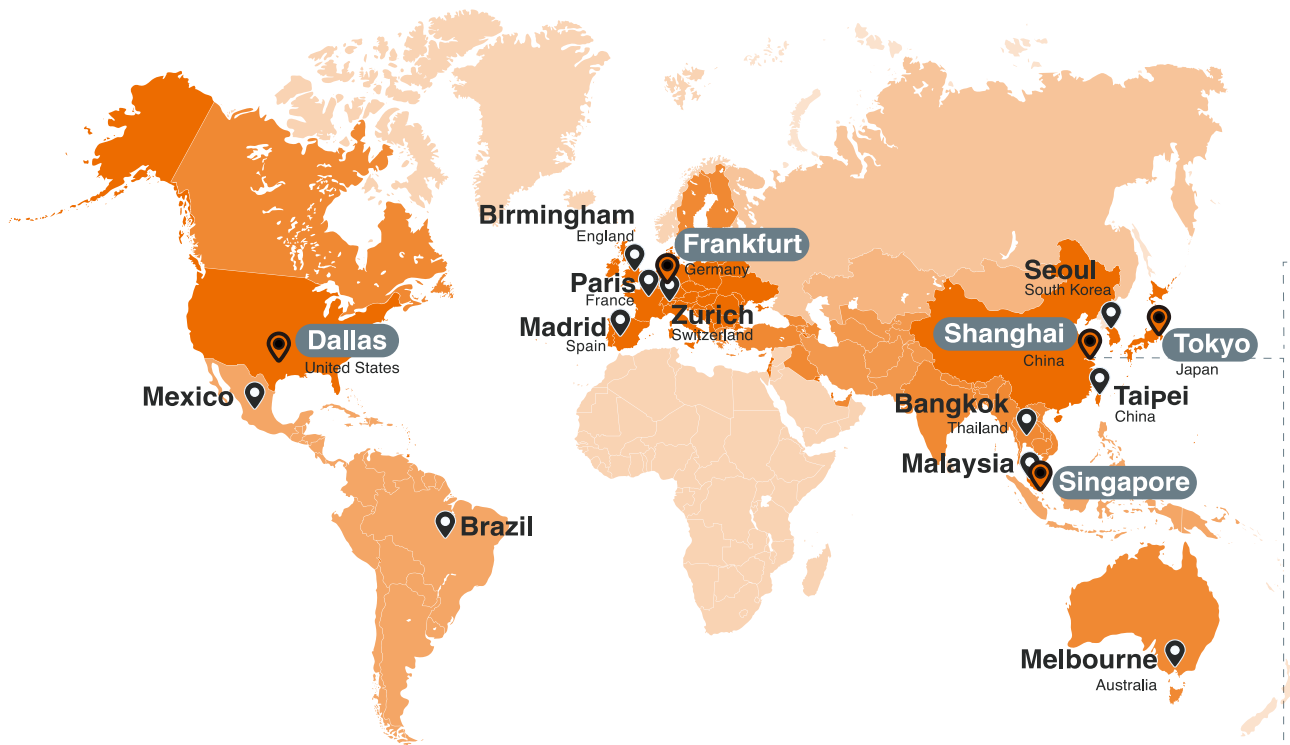

Headquarter



Global Innovation Park

Shanghai

92,000 m²
Innovation Centre & Factories



Manufacturing Center

Suzhou

40,000 m²
Aims to produce 50,000 units annually

KION[™]

GROUP

Series C+ Investment
Strategic Partner for joint R&D

Linde

STILL

Joint product development
Long-term sourcing agreement

DEMATIC

Optimized marketing &
distribution networks

KION



2020

- Aug** Forged strategic partnerships
- Nov** Secured series C+ strategic equity investment
- Dec** Launched two PoC demonstration projects in Australia and Europe

2021

- Jan** Proposed the joint development of a forklift (F100)
- Mar** Initial integration of the software
- Dec** Delivered jointly developed forklift (F100) globally

2022

- May** Started production of KION Group white-labeled products for Linde, Dematic, and Still.

Alibaba



2016

Quicktron deployed 200 robots in a project for Alibaba's logistics arm, Cainiao.

2017

- Established a strategic partnership with Cainiao and secured a series B investment.
- Started building the first smart robotics warehouse in Southeast Asia.

2020

Deployed 500 robots to various sites in Huiyang, Jiangxia, Nanjing, and Haikou, expanding the total delivery to 1,700 robots.

2018

Successfully deployed over 1,000 robots within a single warehouse spanning 30,000 m², elevating the total robot delivery count to 1,200.

2021

Initiated global expansion by delivering 250 robots for overseas projects in Germany and Thailand, resulting in a total delivery count of 1,950 robots.

Goods-to-Person

Pallet-to-Person

Bin-to-Person

Shelf-to-Person

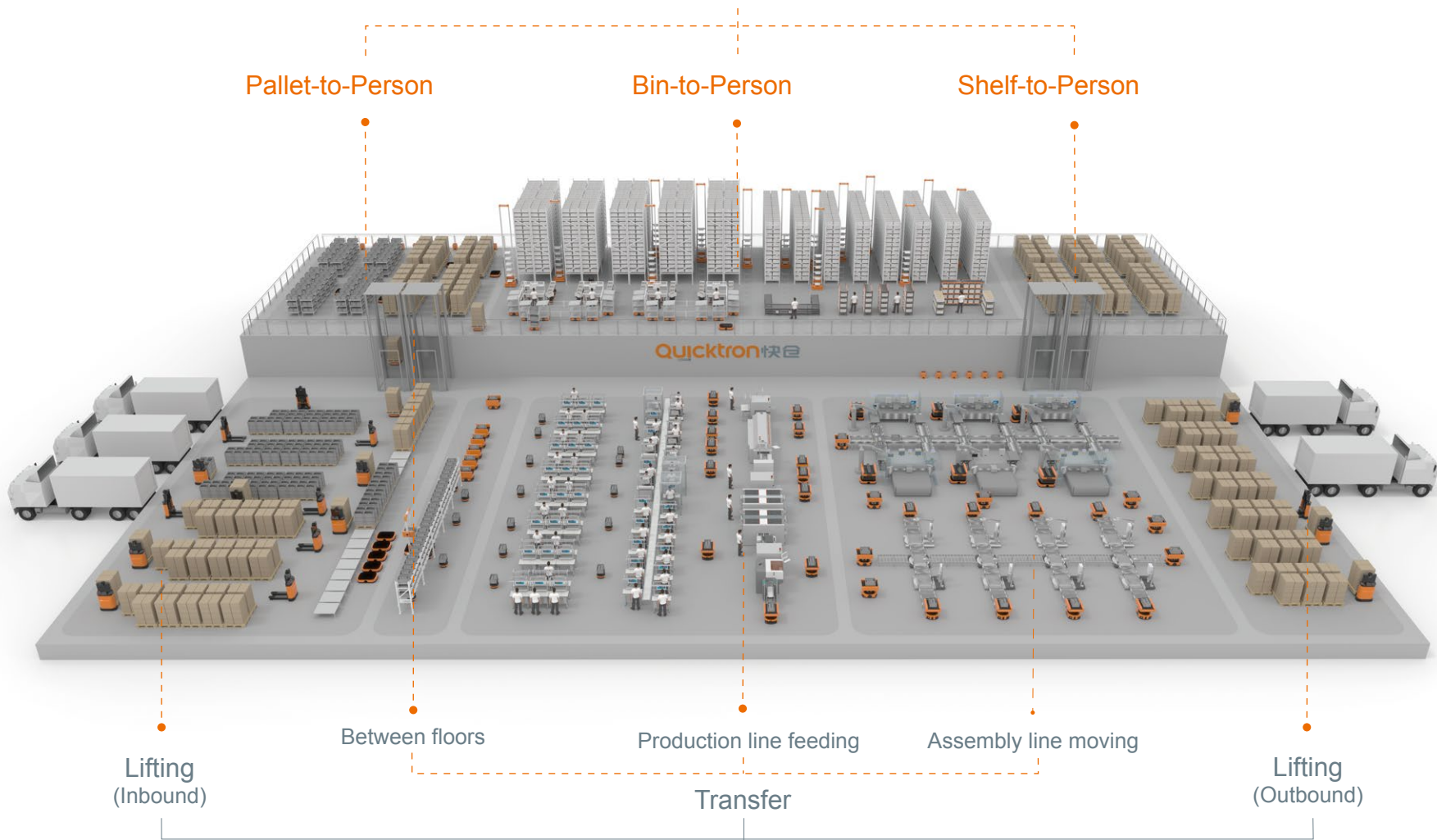

Lifting (Inbound)

Between floors

Production line feeding

Assembly line moving

Lifting (Outbound)

Transfer

Point-to-Point

QuickBin™

Your Path to Optimal Warehouse Automation

High-density Storage + Faster Picking

QuickBin™ is our patented bin-to-person technology that optimizes warehouse operations by utilizing two types of robots. Picking robots (C56) navigate the aisles, storing, retrieving, and sorting goods within the storage area, while mini-moving robots (M5) ensure the smooth movement of goods between storage and workstations. This unique bin-to-person technology empowers your operations with a profound level of productivity, and agility, enabling 3-4 times greater efficiency compared to manual processes.

Maximize Storage: Redefine Operational Efficiency

- Maximizes space utilization providing **75%** more storage
- Soar up to **32.8ft (10m)** with enhanced inventory management
- Process orders **4X** faster compared to manual picking
- Increases picking efficiency: **400-600** order lines/h/station
- Offers flexible expansion options
- Processes **400-600** order lines/h/station



QuickBin™

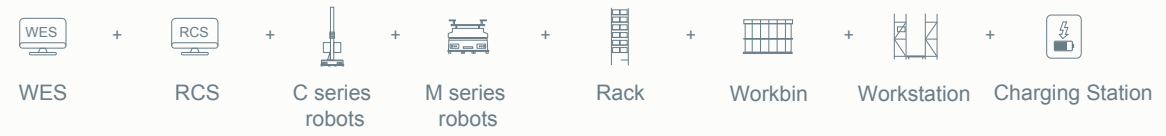

Goods-to-Person Picking

Precision in Every Pick, Delight with Every Delivery

Quicktron's Goods-to-Person (GTP) picking is a warehouse automation solution that uses robots to bring the goods to the picker, rather than the picker having to go to the goods. It involves strategically storing multiple SKUs in sections of shelving, pallets, or bins which are then transferred to workstations using autonomous mobile robots (AMRs). This system employs advanced robotics and AI algorithms to store goods on racks and then deliver goods to workstations while optimizing the process, eliminating unproductive tasks minimizing human intervention, and maximizing efficiency. With Quicktron's Picking solutions, businesses can efficiently handle higher order volumes while maintaining accuracy, making it an essential tool for modernizing logistics operations.

- Scenario-specific design adaptable to changing needs
- Precise operations providing **99.99%** accuracy

- Labor costs reduced by **60-80%**
- Picking efficiency increased by **400%**



Bin-to-Person



Shelf-to-Person



Pallet-to-Person



Smart Moving

A Step Toward Unmanned Operations!

Our smart moving solution is an advanced point-to-point material handling technology that uses mobile robots equipped with QR codes, SLAM, or hybrid navigation technology, and ensures the smooth mobility of goods within a warehouse or factory floor. The advanced sensors enable these robots to navigate complex environments and perform a variety of tasks like transfer and lift as well as moving pallets, goods, parts, and half-finished products in different application settings. This solution uses a combination of RCS and LES to ensure efficient task handling. AMR+ series robots can be customized with belts, double roller conveyors, robotic arms, and other mechanisms based on the client's specific needs.

- Seamless integration with MES/ERP/WMS/SCADA System
- Precise handling with **99.99%** accuracy

- Efficiency boosted by **3-4X**
- Labor cost reduced by **40-60%**



Transfer



Lift



Handle



LES
LES

RCS
RCS

Forklift
Forklift

AMR+
AMR+

Pallet
Pallet

Charging Station
Charging Station

Intelligent Software Platform

Taking Intralogistics Performance to New Heights

Quicktron's robust software ecosystem encompasses a seamless integration of WES, LES, and RCS, harmoniously interfacing with upstream systems such as WMS, ERP, MES, MIS, OMS, and TMS, these systems work in tandem in a variety of configurations to streamline logistics operations. It includes resource allocation, inventory distribution, multiple equipment coordination, traffic control, routing, and other processes that enable businesses to meet the evolving demands of modern intralogistics with efficiency and agility.

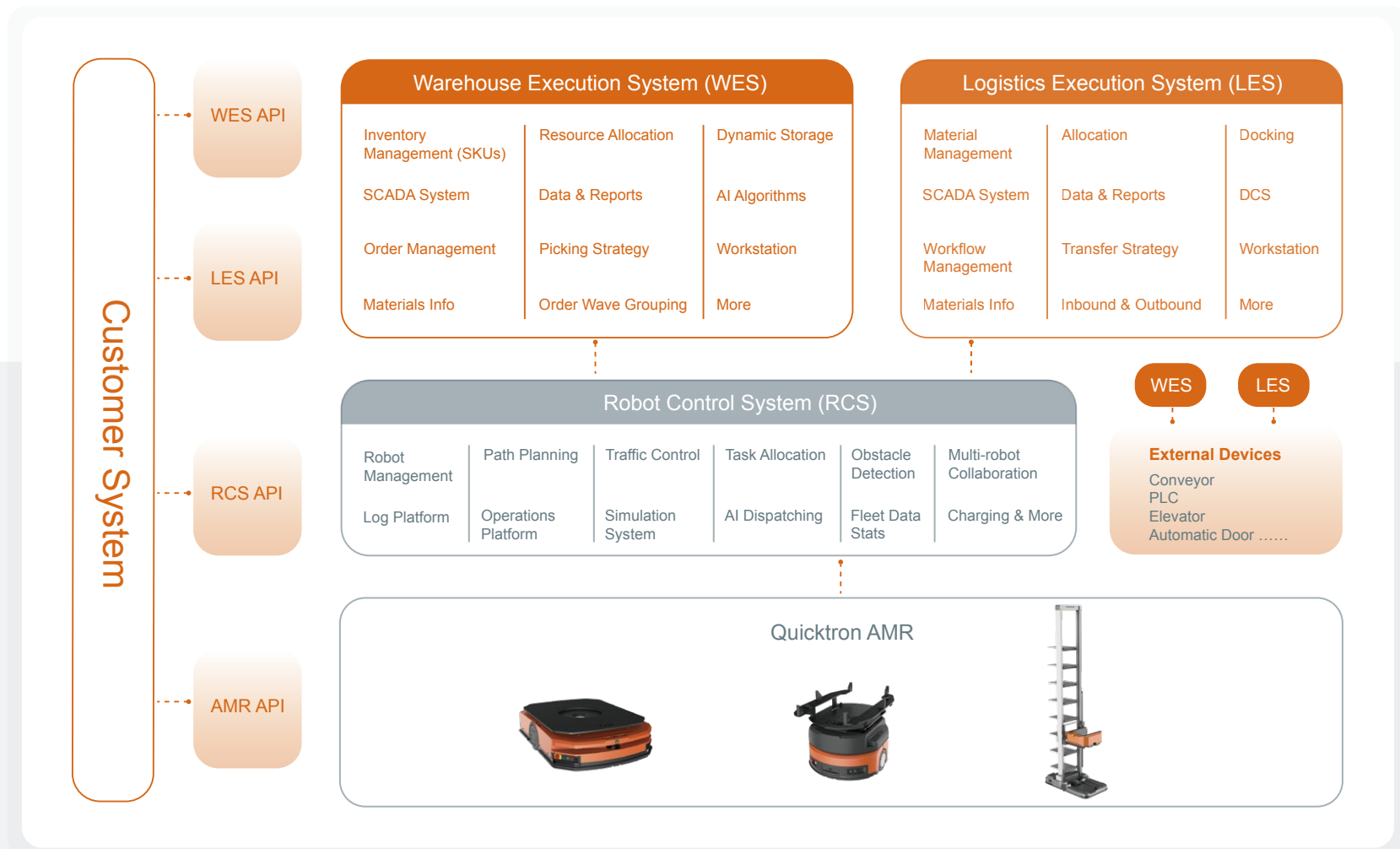

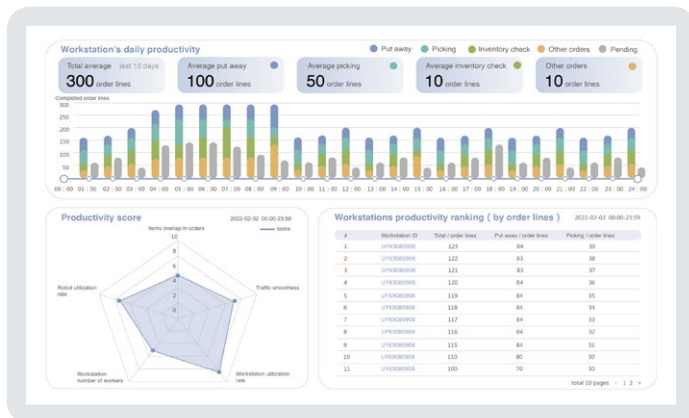

Data Platform

Real-time monitoring of task execution efficiency, hardware, and traffic status.
 Interactive and user-friendly interface makes the data navigation and control much easier.

Smart Dispatching

In 2020, Quicktron introduced industry-leading dispatching algorithm, which enables comprehensive operation of several robots at multiple locations inside the same facility.

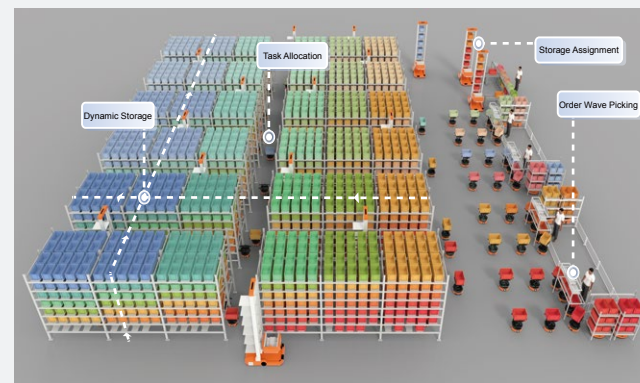

Simulation System

If required by the client, the system can provide simulated videos and reports based on pattern recognition and a wealth of data from prior application scenarios to ensure the best-suited solution, which can boost storage efficiency, reduce costs, and increase throughput. In smart moving applications, Quicktron robots can also effectively coordinate with other equipment. We have completed the Industry's first 60,000m² facility simulation successfully.

Algorithms

Multi-Robot Coordination

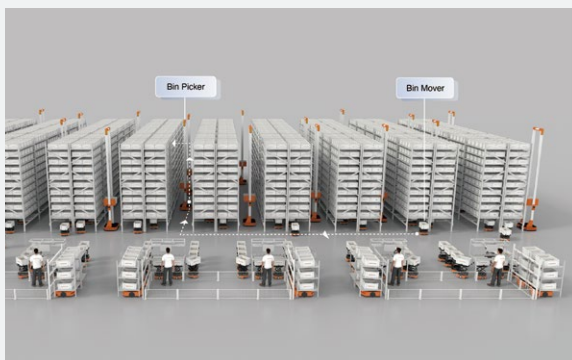

With the combination of heuristic and exact integer algorithms, Quicktron can execute seamless coordination among hundreds of robots performing tasks simultaneously. Additionally, in QuickPick application scenarios, two different types of robots efficiently work together. In smart moving applications, Quicktron robots also effectively coordinate with other equipment.

Path Planning

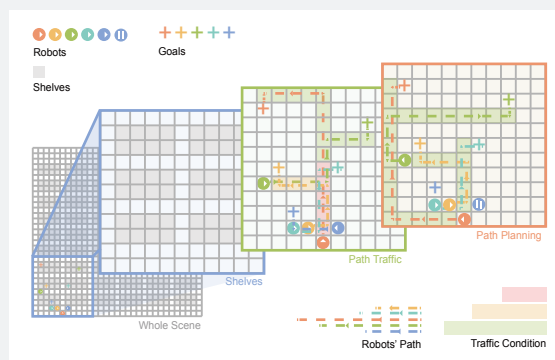

To maximize the traffic efficiency and ensuring seamless high-speed operation, the shortest optimal path is planned for each robot, which immediately switches to re-planning mode in case of any irregularity.

Task Allocation

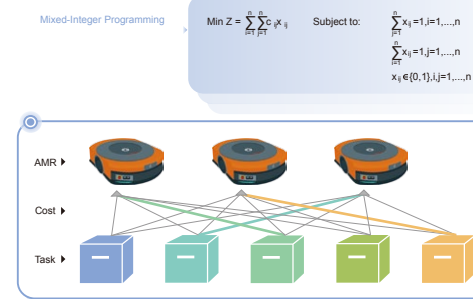

Dynamic tasks allocation reduces robot detours and idle time, enhancing overall productivity. Robots follow one another in 1-2 seconds interval saving the operator's waiting time.

Algorithms

Dynamic Storage

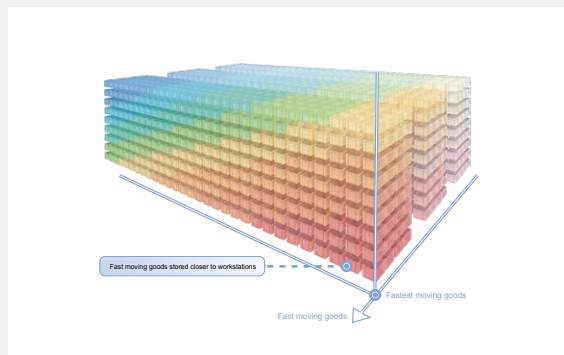

The system predicts the future demand by analyzing order history to determine the optimal location for shelves and bins.

Optimized storage shortens the distance to workstation, enhancing picking efficiency.

Storage Assignment

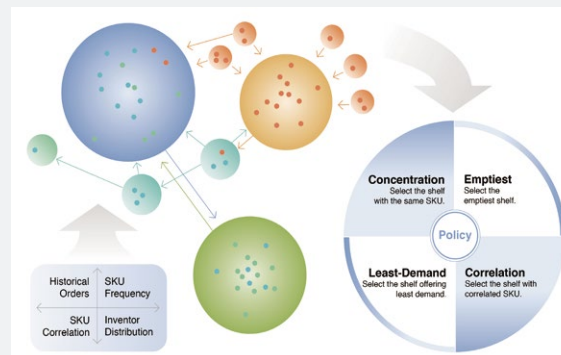

Diversified inventory

Analysis of product size, SKU frequency, and other order parameters allows the better storage space management and inventory diversification.

Centralized storage of related goods

The system analyzes outgoing orders to group related goods, enhancing shelf hit rate.

Order Waves Grouping



Based on order and SKU correlation analysis, the system generates optimal order waves for picking one order at a time or multiple orders simultaneously.

Case Studies

E-commerce

3PL

Apparel & Shoes

Manufacturing

Pharmaceutical

Electronics

Automotive

Beauty

Retail

Food

Photovoltaic





Wuxi, China



Asia's Largest Mobile Robot Deployment in a Single Warehouse!

Cainiao Group is a global smart logistics company and the logistics arm of Alibaba Group. It carries forward Alibaba's mission of making it easy to do business anywhere by aiming to deliver anywhere in China within 24 hours, and across the globe within 72 hours.

Challenges & Solution

Cainiao set its sights on achieving 24-hour delivery within China and 72-hour global delivery. To realize this vision, they sought an innovative solution to automate their warehouse operations effectively.

Quicktron provided a customized Goods-to-person solution with different product zoning and picking methods. This solution helped Cainiao build China's first IoT intelligent robot warehouse. Leveraging AI-powered robotic systems, Quicktron optimized processing rates and enabled unmanned material handling. The warehouse automation enabled Cainiao to efficiently deliver on its smart logistics goals, with outbound orders prepared and ready for delivery within an impressive 15 minutes.

Project Highlights

30,000 m²

Automated area

1000+

M-Series AMRs

350

Workstations

34,000

SKUs

Picking efficiency: 600 pcs/hour/station

99.99% Accuracy

Outbound efficiency increased by 30%



Quanzhou, China



Redefining Efficiency in Tea Industry with Goods-to-person Automation

BAMA brand is a prominent leader in China's tea chain and holds a significant presence in the high-end tea market. Additionally, it boasts a well-established and extensive e-commerce supply chain.

Daily orders: 5,000

Inventory: 200,000 items

Order profile: 53% single item orders

Challenges & Solution

To enhance online sales, expedite delivery, and customer experience, the artisan tea brand needed a robotic solution for its e-commerce warehouse automation.

Quicktron's Goods-to-Person solution, powered by 18 AI-driven mobile robots, was implemented to optimize BAMA's warehouse operations. In the limited storage facility, Quicktron's robust warehousing software strategically positioned racks and pallets containing high-selling items in front, ensuring a swift and efficient retrieval process. This innovative solution enabled Bama to fully utilize the available space and resulted in a remarkable 2 times increase in picking efficiency.

Project Highlights

2000 m²

Automated area

18

M-Series AMRs

8

Workstations

184

Shelves

Labor cost decreased by **30%**

Accuracy **99.99%**

Daily orders **5000**

South Korea



coupang

Automated Coupang's largest logistics center in South Korea.

Coupang is a South Korean e-commerce company that is known for its fast delivery speeds, wide range of products, and convenient shopping experience. The company is often referred to as the "Amazon of South Korea" due to its dominance of the South Korean e-commerce market.

Challenges & Solution

Escalating e-commerce demands prompted the need for rapid, and precise order fulfillment. To stay competitive and curtail error rates, an automation system that met these requirements was essential.

Quicktron orchestrates the entire picking process through 600 AMRs, employing a shelf-based goods-to-person picking. These robots adeptly handle inbound, replenishment, inventory counting, and sorting tasks, while our RCS system seamlessly integrates with upstream systems for efficient task handling and resource allocation. This intelligent warehouse management significantly amplifies overall operational efficiency and garners considerable labor cost savings for Coupang.

Project Highlights

60,000 m²

Quicktron automated area

700

Shelf-to-person robots

33

Workstations

Daily picking capacity **60,800 pieces**

Working hours: **16 hours**

Operational efficiency increased by **300%**

Accuracy **99.99%**

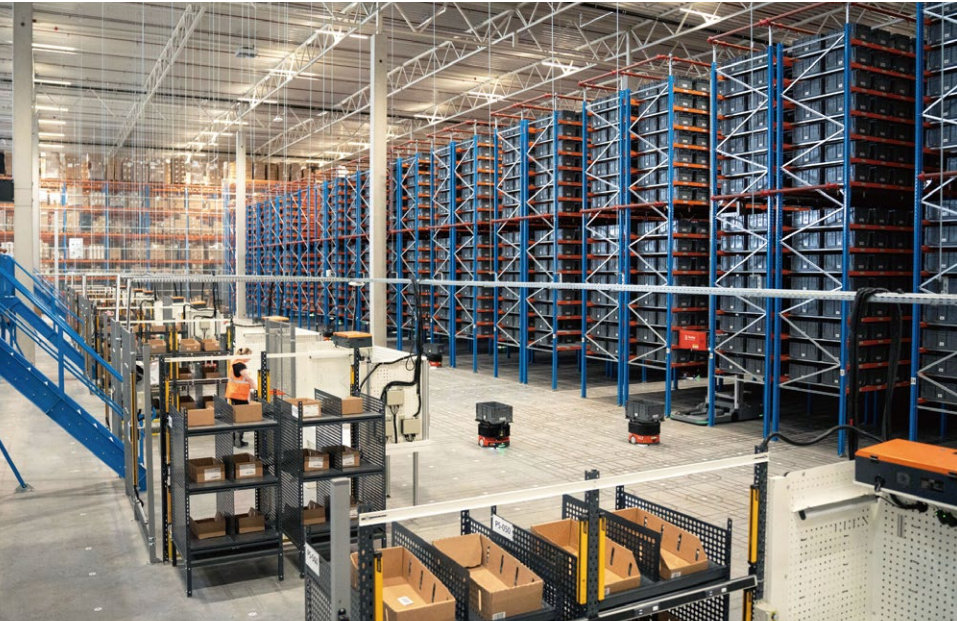

Holland Netherland



Global First-ever Hybrid Goods-to-person Project: Efficiency Redefined!

Radial Inc. leads E-commerce with fulfillment, and tech solutions for premier brands, ensuring high-value customer experiences, flexibility, scalability, and business focus.

Challenges & Solution

Radial Inc grappled with a challenge - escalating e-commerce orders demanded agile automation. Seeking streamlined resource allocation, they aimed to consolidate the storage of varied items under one roof for centralized processing.

Quicktron provided a tailored fix by integrating RCS, WCS, and WES software with Radial's WMS, alongside equipped workbenches and safety measures. This hybrid solution fuses QuickBin and pallet-to-person solutions, effectively addressing flow and storage needs. This allows the handling of totes, pallets, and shelves, all at once through centralized workstations, and second, the automated replenishments of the put-away walls to fast-track fulfillment operations. Quicktron introduced dual picking points to minimize operator idle time, Inbound and returns stations were also combined to optimize tote utilization.

Project Highlights

8500 m²

Automated area

299

Total AMRs

Efficiency: **40,000 OL/day**
 Saving Labor Cost by **40%**
 Hybrid workstations
 Dual picking points
 Put wall with auto-replenishment

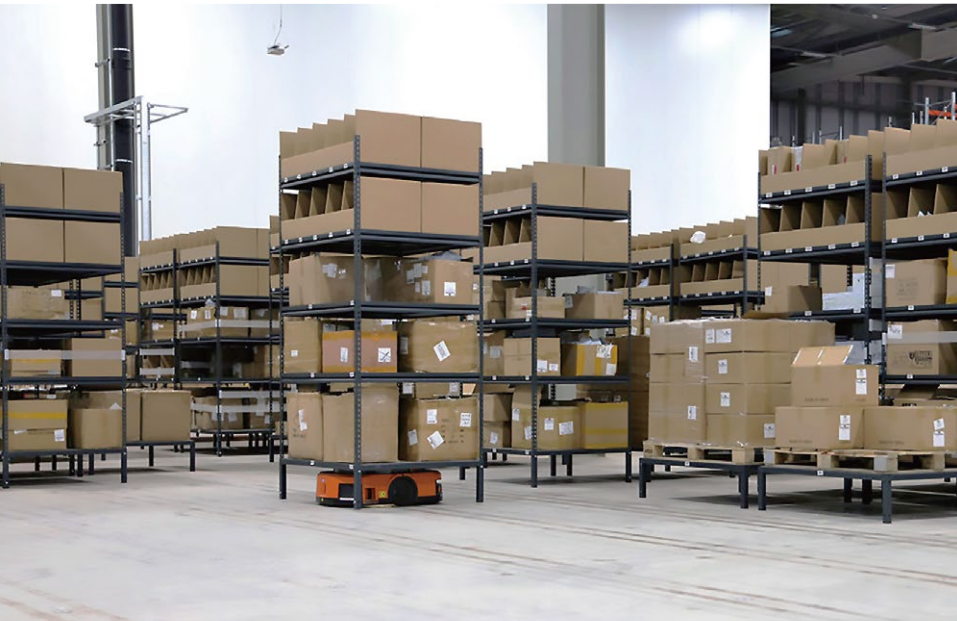

Worcester, United Kingdom



Reliable Cross-border E-commerce Using Smart Robotics.

CIRRO Fulfillment is a third-party e-commerce warehousing and logistics service company. They offer a wide range of services, including order fulfillment, inventory management, returns processing, and shipping.

3PL servicing cross-border e-commerce
Daily orders: 17,000
Order profile: 85% multi item orders

Challenges & Solution

CIRRO Fulfillment faced significant challenges in handling multi-item orders efficiently, labor shortages, and maintaining reliable services during pandemic restrictions. Manual material-handling processes hindered productivity and posed a risk to customer satisfaction.

Quicktron's shelf-based GTP solution with 128 M series robots revolutionized CIRRO Fulfillment operations. It streamlined multi-item order management, overcame labor shortages, and ensured uninterrupted services during pandemics. Quicktron's AI-powered inventory management system seamlessly orchestrates product handling with unmatched precision and provides real-time insights for informed decisions. With our AI software-controlled inventory management they sped up threefold compared to manual operations. Their team now fulfills 17,000 orders daily, signifying a remarkable boost in efficiency.

Project Highlights

10,200 m²

Automated area

128

M-Series AMRs

11

Workstations

58,641

SKUs

Labor costs decreased by **30%**
Inventory: **2 Million Items**



Los Angeles, USA



Simplifying Cross-border Fulfillment Through Goods-to-person Automation

4PX is a global logistics company that provides a wide range of services, including cross-border e-commerce logistics, warehousing and fulfillment, and supply chain management.

3PL servicing cross-border e-commerce

Daily orders: 5,000

Order profile: 53% single item orders

Challenges & Solution

4PX owns and operates a network of 7 warehouses worldwide, servicing 20,000+ businesses.

A newly built warehouse in the US is one of the company's latest strategic additions.

Automated picking allowed 4PX to efficiently process a large number of SKUs owned by different merchants. The company implemented a "one order at a time" fulfillment strategy to ensure optimum convenience for the operator.

Project Highlights

8000 m²

Quicktron automated area

82

M-Series AMRs

15 (picking)+7 (putaway)

Workstations

2456

Shelves

Storage capacity increased by **200%**
 Picking efficiency: **230 pcs/hour/station**
 Inventory: **200,000 Items**

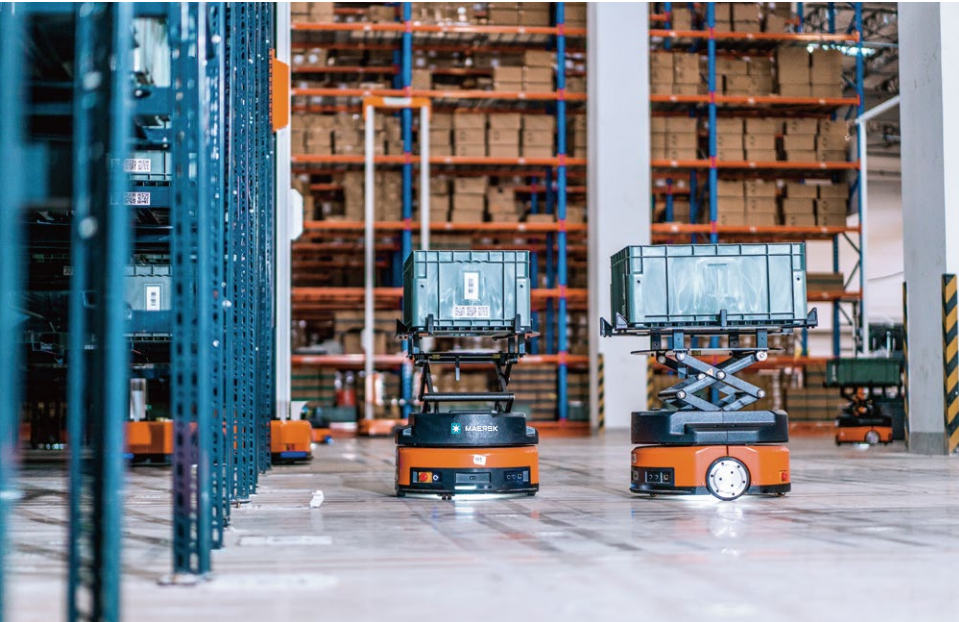

Shanghai, China



Seamless Omni-channel Fulfillment Using QuickBin Solution

A.P. Moller - Maersk is an integrated logistics company. It also offers distribution and fulfillment solutions within retail, wholesale, and e-commerce.

Challenges & Solution

Specialized in omnichannel service, Maersk needed an automation solution for their apparel client. Implementation of QuickBin allowed Maersk to increase picking efficiency for B2B and B2C orders, reduce labor cost, and ensure order fulfillment uninterrupted by holidays and seasonal spikes.

Flexible installment by parts minimized disruption to daily operations. A reduced team of 6 people handled orders influx during China's biggest shopping festivals 3 times more efficiently.

Project Highlights

1200 m²
Automated area

84
Total AMRs

6
Workstations

Storage capacity increased by **60%**
Picking efficiency in peak season increased by **300%**
Inventory: **3000 SKUs, 400K items**

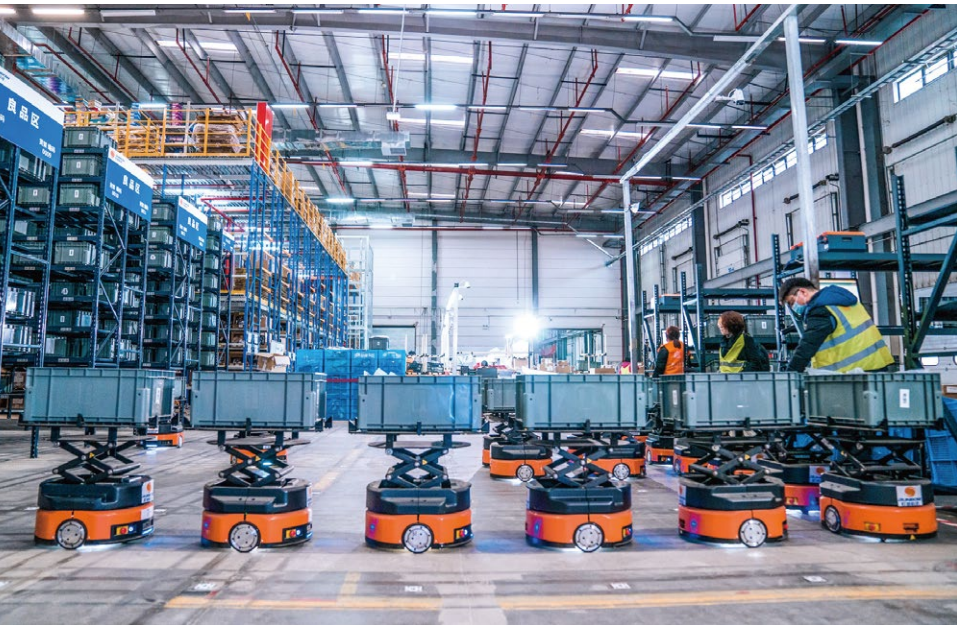

Shanghai, China



Meeting the Needs of a Diversified Customer Base.

Runbow is one of the fastest-growing 3PL service providers in China, its business network covers more than 95% of the domestic market.

3PL servicing apparel brand

Challenges & Solution

Runbow struggled to retain workers and faced the burden of costly training for new employees. Additionally, the expanded international client base posed challenges in managing inventory efficiently with manual operations.

Quicktron's QuickBin solution, powered by 73 mobile robots and advanced warehousing systems, addressed Runbow's efficiency challenges. The vertical storage capability provided extra space savings and maximum height utilization. The integration of robots streamlined inventory management, reducing costs and enabling swift, uninterrupted deliveries. Runbow reaped the benefits of improved productivity, reduced labor turnover, and enhanced customer satisfaction.

Project Highlights

1000 m²
Automated area

73
Total AMRs

4
Workstations

Outbound volume: **1000 pcs/hour/station**
Efficiency increased by **500%**
Labor cost saved by **65%**
Inventory: **180,000** Items



Bremen, Germany



World's Largest Bin-to-person Warehouse.

WINIT, a supply chain management solution provider, aims at helping cross-border E-commerce businesses manage their inventory turnover and end-to-end fulfillment costs more efficiently.

3PL serving cross-border e-commerce

Challenges & Solution

Winit grappled with the complexities of cross-border fulfillment services, hindered by overwhelming orders and slow traditional handling. Integrating robots with existing conveyors was also a challenging task.

Quicktron's patented QuickBin solution provided the remedy. This innovation fine-tuned inbound processes, streamlined picking, and seamlessly connected robots with conveyor belts. It also optimized high-density storage for numerous SKU items, elevating picking efficiency. The warehousing system efficiently allocated goods, strategically positioning hot-selling items for rapid fulfillment. Consequently, Quicktron's solution significantly enhanced Winit's order processing speed and precision, while ensuring streamlined cross-border fulfillment operations.

Project Highlights

8000 m²
Automated area

154
Total AMRs

16
Workstations

Inbound efficiency: 1500 bins/hour/station
Efficiency increased by 300%
Inventory: 15,000 SKUs
Labor cost saved by 65%



Dubai, United Arab Emirates



The First Robotic Fulfillment Solution in the MENA Region.

IQ Fulfillment is a technology-driven fulfillment company that provides a wide range of services to e-commerce businesses in the MENA region.

Challenges & Solution

IQ Fulfillment faced the daunting task of meeting digital transformation challenges brought about by the e-commerce boom. They needed to optimize their warehousing capacity and speed by integrating robots with existing conveyors.

Quicktron's shelf-based Goods-to-person solutions, featuring 40 M-series robots, revolutionized IQ Fulfillment's warehousing operations. The seamless integration of our robotic system with their existing conveyor belts resulted in a remarkable four-fold boost in fulfillment speed. With a lean team of only 12 people, IQ Fulfillment now offers one of the fastest delivery services across the Middle East region. Quicktron's advanced technology enables them to successfully navigate the demands of e-commerce and deliver exceptional results to their customers.

Project Highlights

1500 m²
Automated area

40
M-Series AMRs

Productivity increased by **300%**
Order Volume: **12,000** daily
Labor cost saved by **60%**



Paris, France

➔ Cubyn

France's First Fully Automated E-commerce Warehouse.

Cubyn is a business-to-business logistics company headquartered in Paris, France. The company offers a tech-enabled order fulfillment service for e-businesses.

3PL servicing e-commerce

Challenges & Solution

Cubyn faced challenges in inventory management and order fulfillment due to rising costs and a complex distribution environment with growing orders. They sought to enhance their efficiency and meet customer demands effectively.

Cubyn implemented Quicktron's QuickBin solution, deploying 300 robots to streamline operations. Integrating our RCS system with Cubyn's WMS system resulted in a remarkable 300% improvement in inventory management efficiency. This solution not only saved costs but also proved sustainable by reducing carbon emissions. Moreover, Cubyn experienced a decrease in order returns and achieved an impressive 99.99% accuracy in order delivery, ultimately enhancing customer satisfaction and positioning Cubyn for sustained growth.

Project Highlights

5000 m²

Quicktron automated area
(1st phase)

300+

Total AMRs

10

Workstations (1st phase)

Efficiency increased by **300%**
Energy consumption saved by **90%**



Thailand

FLASH
EXPRESS

CAI
N!ΔO

Thailand's Largest Mobile Robots Warehouse!

Flash Express is an integrated e-commerce logistics service provider and integrated service delivery platform under the Flash Group, which covers Thailand, the Philippines, and Malaysia.

Industry: 3PL servicing e-commerce
Order volume: 12,000 - 28,000 orders/day

Challenges & Solution

Facing mounting delivery demands due to the e-commerce boom, Flash Express encountered significant challenges in achieving its ambitious delivery goals: 1-2 days domestically and 3-7 days across Southeast Asia.

Quicktron's robotic goods-to-person solution is seamlessly integrated with flat belt conveyors, inclining conveyors, balance wheel sorters, case unpackers, and other automation equipment. With this streamlined flow, Flash Express maximized its productivity and reduced delivery time all while minimizing errors. With the optimized processing rate they are meeting the delivery goals efficiently.

Project Highlights

5000 m²
Automated area

168
M-Series AMRs

12 (16 for peak season)
Workstations

996
Shelves

Picking efficiency: **350 items/hour/station**
99.99% Accuracy



Bremen, Germany



Effortless Global Fulfillment via Goods-to-Person Automation.

4PX is a global logistics company that provides a wide range of services, including cross-border e-commerce logistics, warehousing and fulfillment, and supply chain management.

Challenges & Solution

4PX Bremen encountered challenges in effectively managing sizeable single-item orders during the picking process. These inefficiencies include delivery delays, returns, and elevated costs in their order fulfillment operations.

A strategic alliance between Quicktron and Cainiao yielded a tailored solution to satisfy the fulfillment needs of 4PX. A fleet of 76 M series robots effortlessly deliver shelves to operators at workstations. This automated picking system allowed 4PX to efficiently process a large number of SKUs owned by different merchants. Real-time data analytics and task allocation further enhanced the picking process while saving storage space for them, immediately tripling their efficiency.

Project Highlights

8000 m²

Automated area

75+

M-Series AMRs

Storage Capacity increased by **200%**

Picking efficiency Boosted by **300%**

Accuracy **99.99%**

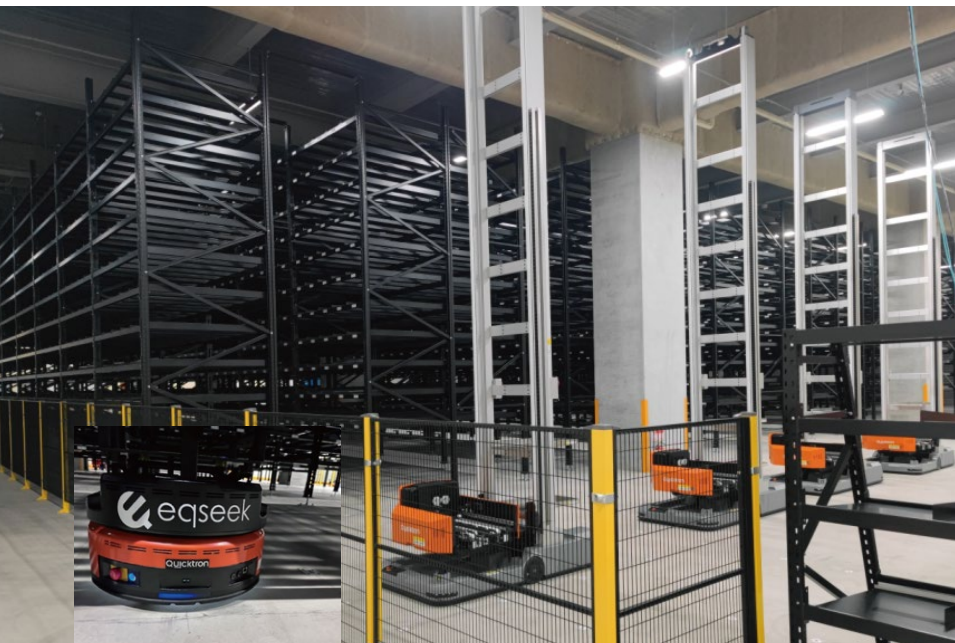

Chiba, Japan



C56 Vacuum Gripper Robots in QuickBin: Elevating Storage Efficiency

EQSEEK CO., LTD. is a Japanese company that provides logistics, internet, trade, and e-commerce services.

Challenges & Solution

Eqseek grappled with limited warehouse space, escalating labor costs, and inefficient operations. Their goal was to minimize labor reliance and enhance overall operational efficiency.

Quicktron implemented a QuickBin solution featuring C56 robots equipped with a vacuum suction mechanism, resulting in a remarkable 4X increase in storage efficiency. Integrated with customers' WMS, our WES system employs AI-driven order history analysis to optimize item placement based on priority. Seamless coordination between WES and RCS expedited goods delivery to workstations through a strategic alliance of C56 and M5 robots. This ensured high throughput and minimal downtime, swiftly resolving Eqseek's challenges and transforming warehouse efficiency.

Project Highlights

1200 m²

Automated area

50

Total AMRs

99.99% Accuracy

Storage Capacity increased by 400%

Picking efficiency Boosted by 400%



Chiba, Japan



QuickBin: A Gateway to Seamless Fulfillment Operations

Mitsui & Co., Ltd. It is a leading international logistics company that provides a wide range of services, including ocean freight, air freight, trucking, warehousing, and customs clearance.

Challenges & Solution

Mitsui & Co. International Logistics faced labor shortages, space constraints, and rising costs, impeding warehouse efficiency and necessitating a solution to optimize storage and reduce manual labor dependency.

Quicktron's QuickBin solution tackled these issues by efficiently managing goods flow through AI Robotics. Tall picking robots (C56) maximized vertical space utilization, reducing manual labor and enhancing storage capacity. These robots, with a reach of 5.8m, sort items on racks based on order history, prioritizing high-demand items for easy access and faster retrieval. Mini robots (M5) managed long-distance bin transportation, ensuring high throughput and minimal downtime. QuickBin's flexibility and reliability ensured uninterrupted operation, swiftly resolving MGL's challenges.

Project Highlights

1000 m²
Automated area

22
Total AMRs

Storage Capacity increased by 200%
Picking efficiency Boosted by 300%
Accuracy 99.99%

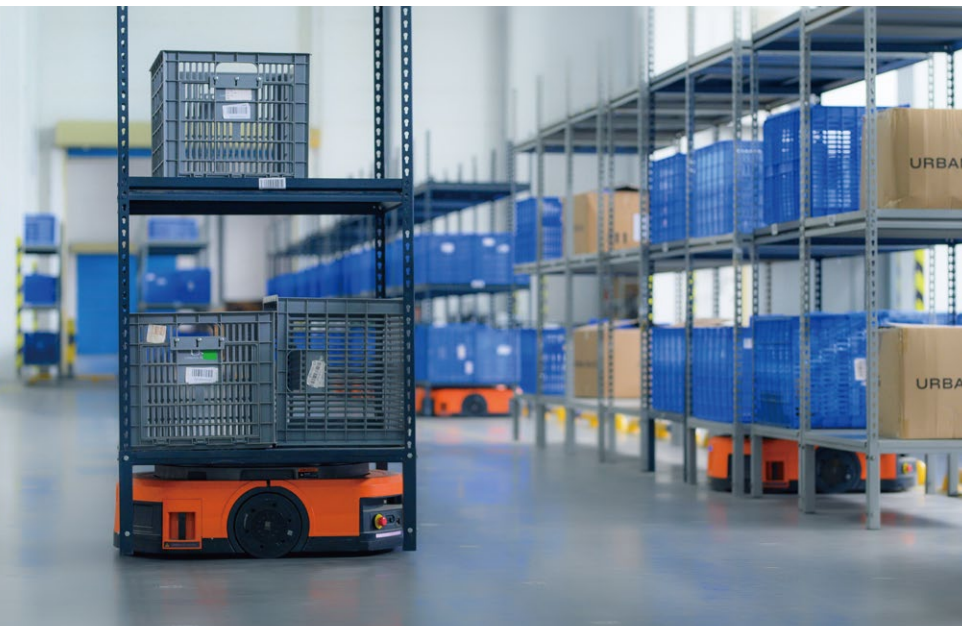

Zhaoqing, China



Robots Boosting Efficiency in Fashion Brand 's Fulfillment Operations!

Urban Revivo is a Chinese fast fashion brand having 1,000 stores in China, Southeast Asia, and the Middle East. Urban Revivo is known for its trendy and affordable clothing and a wide variety of accessories, shoes, and bags.

Challenges & Solution

To meet modern delivery demands, Urban Revivo's manual warehouse struggled to keep pace, leading to inefficiencies in order processing. They required automation that can enhance efficiency without major structural changes.

Quicktron emerged as a savior, delivering robotic shelf-based GTP systems integrated with conveyor belts. This innovation led to a remarkable 30 percent efficiency increase and expanded storage capacity by 15%. Today, Urban Revivo smoothly fulfills its B2B orders, dispatching 6 million items monthly to UR stores.

Project Highlights

4500 m²

Automated area

40

M-Series AMRs

10,000

SKUs

Picking efficiency boosted by **300%**

Inventory **200,000** items/day

Storage efficiency boosted by **15%**

Labor cost reduced by **30%**

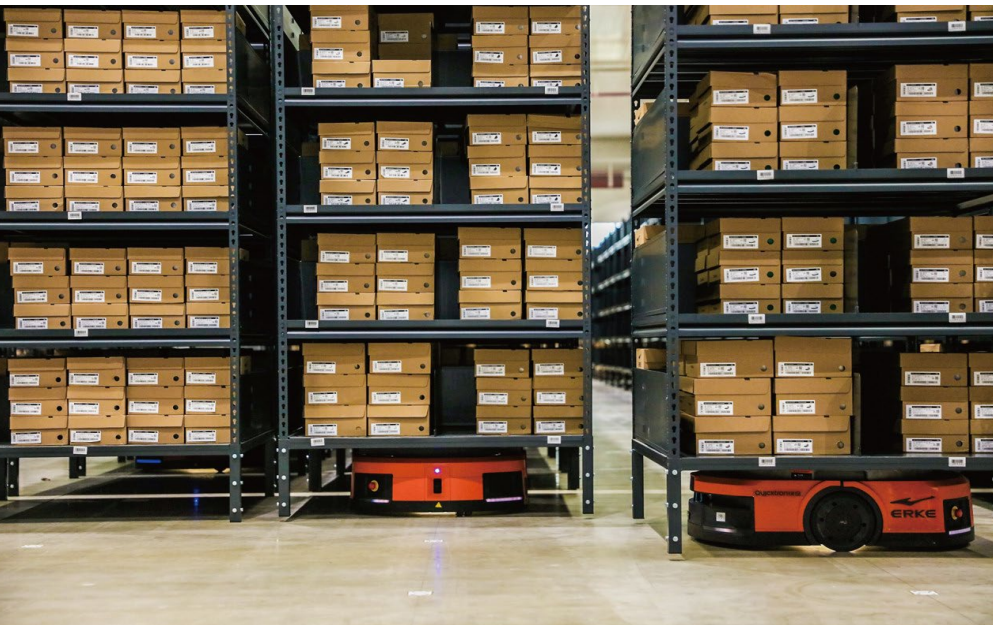

Xiamen, China

Automation for One Of The Largest Shoe Brands.

Erke is a multinational sportswear and shoe company with 7000 stores in China.

Order volume: 2000 orders/hour

Challenges & Solution

Erke faced tough competition from established foreign rivals, necessitating supply chain improvements to meet rising demands and overcome delays in order fulfillment, which impacted customer satisfaction and threatened their market position.

Erke partnered with Quicktron to deploy 56 mobile robots for efficient goods-to-person handling. Quicktron's software platform optimized SKU storage, increased shelf hit rate, and ensured smooth order fulfillment even during peak demand, with sales surging up to 52 times. As a result, Erke now handles 2000 orders per hour, strengthening their competitive position, enhancing customer satisfaction, and paving the way for sustained success.

Project Highlights

56

M-Series AMRs

8

Workstations

1200

Shelves

Efficiency increased by **300%**

Picking efficiency: **2 mins** from order to delivery



Dongguan, China

YISHION

Smart Production With Robotics And 5G Connectivity.

Yishion is a Chinese fast fashion brand that offers trendy, affordable, and comfortable apparel for men, women, and children. It has over 6,000 stores worldwide and is one of the leading fast fashion brands in the industry.

Challenges & Solution

In response to evolving market demands characterized by frequent small-batch orders and the need for urgent order prioritization, the company needed a transition from the rigid "production line" to flexible "production processes." This shift aimed to address challenges such as resource allocation inefficiencies and prolonged lead times, adapting to varying worker skill sets.

Quicktron offered a transformative solution by introducing a 5G-enabled smart moving system. This innovation assigned tasks to workers based on their strengths, aided by robots delivering materials via 5G-connected points. This approach optimized production, enhancing efficiency and output in the face of complex operational challenges, and connected the manufacturing processes with the help of robotics.

Project Highlights

457 m²

Automated area

7

M-Series AMRs

55

Shelves

Output Efficiency increased by **34%** per worker
Energy Consumption saved by **90%**



China



Revolution in Toy Manufacturing with Smart Robotics!

Golds is a renowned manufacturer of toy building bricks. As the top supplier of toy building bricks, their current annual total production exceeded 10 billion pieces.

Challenges & Solution

Golds Company, a toy building brick manufacturer, faced persistent complaints about slow deliveries and errors. Seeking to address this challenge and expedite the delivery of MOC parts, Golds required a cost-effective automation solution.

Quicktron stepped in and revolutionized Golds' e-commerce warehouse through intelligent mobile robots, automating material handling tasks. The impact of our shelf-based GTP system was remarkable - speed and efficiency surged by 3-4 times. By optimizing storage, material transfer, sorting, and packaging with advanced warehousing systems, orders are now processed

Project Highlights

1000 m²
Automated area

50
Total AMRs

Accuracy **99.99%**
Efficiency Boosted by **200%**



Vietnam

MPE

Empowering Vietnam's Manufacturing Industry With Smart Robotics!

MPE Smart Factory specializes in the production of lighting products and electrical equipment. With a total investment of 2 trillion Vietnamese dong, the factory has an annual production capacity of 100 million units.

Challenges & Solution

MPE, striving for cost-efficient and secure intralogistics, aimed to embrace the lights-out factory concept and enable 24/7 operations. Their goal was to automate material handling and enhance workplace safety while reducing labor costs.

Quicktron, in collaboration with Linde, brought this vision to life. By fully automating MPE's factory, our robots (AMRS) navigate seamlessly using QR and RFID navigation, optimizing material handling efficiency. With a remarkable 99.99% stacking accuracy, they eliminate errors stemming from human factors. This round-the-clock operational system is redefining the logistics landscape, revolutionizing the industry with efficiency and reliability.

Project Highlights

4000 m²
Automated area

15
M-Series AMRs

Accuracy **99.99%**
Cost savings: **60%**



Taizhou, China

JESDY® 全时代®
Smart Robotics for Smart Manufacturing.

The JESDY Company, founded in the 1990s, originated from Zhejiang Taoyuan Copper Industry Co., Ltd. It is the world's leading fluid intelligent system overall solution provider.

Challenges & Solution

Quicktron solutions enable customers to transition from traditional manufacturing modes to smart manufacturing modes, achieving goals such as product innovation, enhanced operational efficiency, improved service quality, and cost reduction. In this project, the software systems utilized are Quicktron's RCS and the customized LES, which has been tailored according to client specifications. The network is provided by JESDY, and Quicktron interfaces with the client's system using standardized interfaces.

By implementing the Quicktron solution, customers can save a total of 2.7 million RMB annually in overall costs, resulting in an overall economic benefit increase of more than twofold.

Project Highlights

4800 m²

Automated area

25

M-Series AMRs

Logistics efficiency boost: 300%
Production efficiency boost: 30%
Accuracy 99.99%
Saving 2.7 Million RMB/ year



Shanghai, China



**SHANGHAI MITSUBISHI
ELEVATOR**

Streamlined Logistics Workflows in a Fully Automated Factory!

Shanghai Mitsubishi Elevator is a leading elevator manufacturer in China that offers high-quality, safe, and energy-efficient elevators for different applications. They've produced over 1 million elevators since its establishment in 1987.

Production capability: 1M+ shaft doors/year

Challenges & Solution

Shanghai Mitsubishi confronted a gamut of challenges, primarily centered around precision and accuracy issues while working with 130 distinct robot types within their smart factory. Ensuring both safety and precision in task execution and seamless transportation to the warehouse emerged as imperatives, prompting the need for a streamlined intralogistics approach.

Quicktron's solution began in warehousing and expanded to the factory, enabling point-to-point transport of 1500 kg loads using M-series robots. A single operator now effortlessly handles spare parts picking, streamlining workflows, and after-sale services. These robots create smooth production line connectivity, boosting safety and auxiliary material handling efficiency while enhancing precision, safety, and operational cohesion.

Project Highlights

6000 m²

Automated area

11

M-Series AMRs

15 sec

Cycle time

Efficiency boost: 3X

Accuracy 99.99%

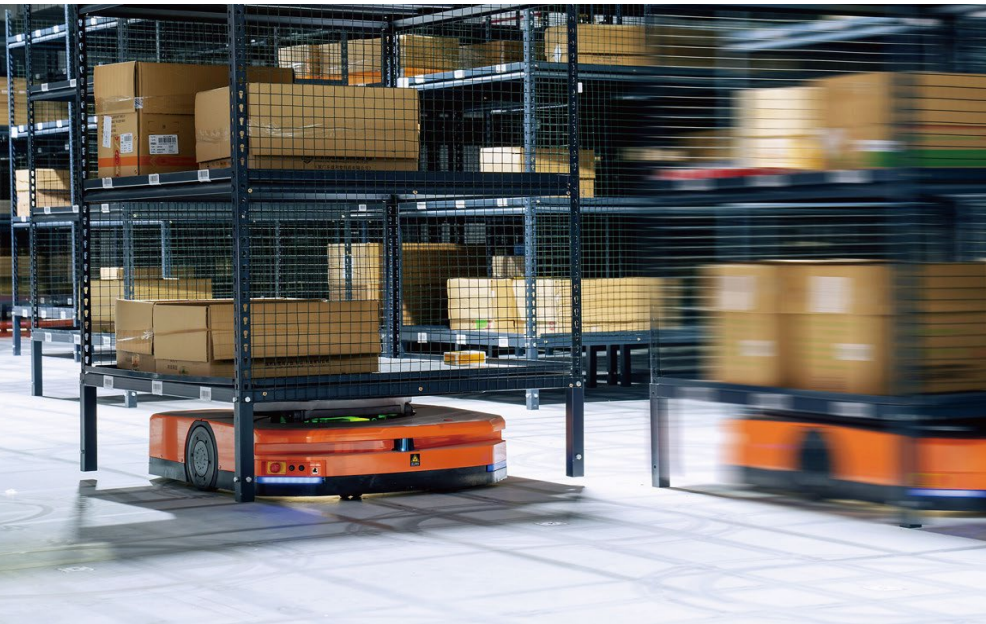

Zhaoqing, China



Redefining the standards of efficiency in medical distribution through Robotics!

Cowell Health is a medical giant in China having a chain of 10,000 pharmacies and multiple hospital services, providing high-quality, efficient, and convenient medical services to patients.

Scale: 10,000 chain stores

Challenges & Solution

Cowell Health, addressing surging medical service demands, sought automation to enhance delivery speed. A temperature-controlled setting required a high-precision, responsive robotic system.

Quicktron's harnessed a shelf-based GTP system for automated picking. Integrating 668 mobile robots with advanced warehousing software brought an astounding 3X operational enhancement across 6 logistics centers. These robots maintained an impressive 99.99% accuracy in a temperature controlled environment while managing 7000 SKUs, tripling overall efficiency.

Project Highlights

8000 m²

Automated area

668

Total AMRs

40

Workstations

7000

SKUs

Accuracy **99.99%**
Efficiency Boosted by **300%**



Pingdingshan, China

**SINOPHARM**

China's first automated pharmaceutical warehouse

The Chinese pharmaceutical conglomerate with business units spanning R&D, manufacturing, logistics & distribution, retail pharma and beyond.

Scale: 100+ institutions

Challenges & Solution

The state-owned pharmaceutical group faced significant challenges in its Pingdingshan warehouse operations, including the need to cut operational costs and eliminate product losses and picking errors. These issues were hindering their efficiency and compliance with regulatory standards.

Quicktron's automation solution provided an effective solution to these challenges. It enabled the pharmaceutical group to achieve strict regulatory compliance, meeting the GSP standard and maximizing storage space. Furthermore, our AI-driven GTP technology significantly reduced operator errors, ensuring high accuracy in both full and split case-picking processes. This solution not only improved operational efficiency but also enhanced overall warehouse performance.

Project Highlights

2000 m²

Quicktron automated area

10

Shelf-to-person robots

3

Workstations

334

Shelves

Space utilization increased by 15%
Warehouse capacity increased by 150%
Picking efficiency: 250 cases/hour/workstation



Shanghai, China

Inventec

Powering production lines with the cross-floor precise material flow!

Inventec designs and manufactures a wide range of electronic products. It is known for its high-quality, innovative, and sustainable products.

Challenges & Solution

Inventec sought to enhance material flow precision and efficiency at its Shanghai factory, encompassing automation for component warehousing, finished product handling, production line automation, and waste movement. Quicktron's AI-driven mobile robots realizes the smart point-to-point material handling, bringing a transformative shift to Inventec's Shanghai factory across various locations within a single building. Transporting up to 600 kg loads, our robots facilitated seamless connections between production lines on distinct floors using elevators, guaranteeing timely deliveries and optimizing the process. The site is divided into two parts PCA and SMT, and for cross-floor production line handling Quicktron's robot system completes the operation tasks of each production line through PDA.

Project Highlights

20,000 m²

Automated area

31

Total AMRs

334

Shelves

Accuracy 99.99%

Streamlined complex production scenarios



Don Mueang, Thailand



Bring the Future to Life with Smart Robotics!

JIB Computer Group, a Thai company, excels in computer and IT product sales. With its self-developed e-commerce website, it has emerged as a leading online tech sales platform in Thailand, drawing around 3.15 million monthly visitors.

Challenges & Solution

JIB aimed to optimize its warehousing operations with intelligent inventory management, elevating picking accuracy, and reducing labor expenses.

Quicktron's solution involved the implementation of shelf-to-person automation using M-series robots. These robots achieved an impressive accuracy rate of 99.99% in material handling. The outcome was a notable threefold efficiency enhancement that eliminated the need for manual involvement. This innovation not only eradicated manual tasks but also cultivated a safer operational environment for JIB.

Project Highlights

760 m²

Automated area

10

M-Series AMRs

Efficiency boosted by **300%**

Accuracy: **99.99%**

Labor Cost Saving: **60%**



Beijing, China



Realizing Lean Manufacturing in Automotive Industry!

Mercedes-Benz is a luxury automaker and has manufacturing plants all over the world. Mercedes-Benz is known for its high-quality cars, SUVs, vans, and trucks.

Challenges & Solution

Mercedes Benz propelled a warehousing logistics overhaul for their comprehensive Beijing production facility, looking for a smart and automated component distribution platform they seek to streamline operations and reduce errors while ensuring safety.

By incorporating Quicktron robots into a lean warehouse management approach, remarkable improvements emerged. Inventory turnover surged by 10%, and storage space utilization saw a significant increase. These AMRs established a seamless and integrated component distribution system, liberating humans from mundane tasks, bolstering efficiency, and drastically reducing costs, all while maintaining uncompromised quality.

Project Highlights

3000 m²

Automated area

8

M-Series AMRs

18000

Inventory

Inventory turnover increased by 10%
Storage utilization increased by 30%
Accuracy 99.99%



Sochaux, France



Taking Manufacturing Efficiency to New Heights Using AMRs.

Stellantis stands as a global automotive giant, ranking fourth worldwide in terms of sales. With a robust presence spanning over 130 countries, the company boasts manufacturing capabilities across 30 nations.

Challenges & Solution

Stellantis faced challenges of precision, accuracy, and productivity in its complex material handling scenarios including docking with existing warehousing systems, managing hundreds of handover points, and coordination of 7 kitting lines.

Quicktron delivered a comprehensive point-to-point robotic solution consisting of 125 mobile robots. We integrated our RCS and WCS system with Stellantis's upstream system for seamless coordination with Callbox, AS & RS, and PDAs to further enhance material flow between storage, kitting, and production lines. With the efficient handling of both small and large-volume pallets, they optimized material flow, leading to increased productivity, reduced errors, and improved manufacturing commitments. Furthermore, the solution offers flexibility for future scaling and process optimization.

Project Highlights

15,000 m²

Automated area

125

M-Series AMRs

20,000 transportation tasks per day
Picking Capacity 552 pallets/hour
Safer Human-Robot Coordination
Logistics Delivery Speed boosted by 20%



Miami, USA



Robotic Revolution in Beauty Business!

OKAY Pure Naturals is a family-owned company focused on natural hair and skincare products. Based in Miami, the company sells products in 500+ stores across the US and Canada.

Challenges & Solution

Driven by swift growth in both online and offline sales, the beauty company grappled with delivery demands, labor shortages, delays, and errors spurring the need to rectify warehousing inefficiencies.

Quicktron Robotics intervened with a game-changing approach, automating operations through a shelf-to-person solution. The impact was striking: orders are now fulfilled with exceptional speed and accuracy, effectively reducing errors. Our warehousing software optimized storage by storing hot selling items closer this enhanced inventory management shortened delivery times, ensuring most orders reach customers within a mere 24 hours.

Project Highlights

2000 m²
Automated area

20
M-Series AMRs

4
Workstations

314
Shelves

Efficiency boosted by **300%**
Realized same-day delivery



Qingdao, China



Grocery Fulfillment: An Enchanting Journey From Order To Delivery

LIQUN Group is a large commercial conglomerate, and its warehouse is responsible for various operations such as O2O, B2B online platforms, handling a wide range of products and fulfilling picking, and distribution services for both online and offline stores.

Challenges & Solution

LIQUN faced pressing challenges in their operations, struggling to meet the demands of swift deliveries while grappling with a concerning rate of errors. These issues were triggering order returns and causing detrimental delays in their processes causing costs.

Through our QuickBin solution, their fulfillment operations underwent a transformation. With 24/7 operations, average order fulfillment time was slashed to 2 hours, ushering in significant cost savings and heightened customer satisfaction. Powered by our RCS and WCS systems, advanced algorithms govern inventory and transportation, ensuring prompt completion of high-priority orders. This advancement empowered LIQUN to effectively cater to its expanding customer base.

Project Highlights

2200 m²

Quicktron automated area

15,600

Bins

61 (C56-16 + M5A-45)

Total AMRs

Picking efficiency boosted by **400%**
Space utilization increased by **60%**



Suzhou, China



Snacks Giant Triples Productivity with Robotics Automation!

Mondelēz International is the world's top snack brand with a portfolio of over 200 brands that generate more than \$30 billion in annual revenue. It is committed to providing consumers with delicious, nutritious, and sustainable snacks.

Challenges & Solution

Mondelēz faced a challenge with their existing ASRS system, lacking automated ground movement for heavy payloads. To enhance precision, safety, and efficiency in material handling, they sought a robust solution.

Quicktron's cutting-edge mobile robot fleet seamlessly integrated with their ASRS system provided the answer. Leveraging our RCS system, these robots achieved material handling with a remarkable accuracy rate of 99.99%. The result was a threefold increase in productivity, realized through precise point-to-point deliveries that eradicated the necessity for manual intervention. This innovation not only eliminated manual tasks but also established a safer working environment for Mondelēz operations.

Project Highlights

12,500 m²

Automated area

32

M-Series AMRs

10,000

SKUs

Per Capita efficiency boosted by **133%**

Error Reduction: **70%**

Overall Cost Saving: **844 K/year**

Operations: **24/7**



Chengdu, China

天味食品 TEWAY FOOD

Transforming Food Production Through Modular Robotics!

TEWAY Food specializes in the production of hot pot soup ingredients □ and offers over 100 bestselling products across four major series. □ These products are not only popular nationwide but also exported □ to overseas markets.

Challenges & Solution

To cope with soaring order demands, Teway sought smarter, more efficient production. Complex integration with existing equipment posed a challenge, compounded by a need to curtail costs linked to inefficient logistics and food loss.

Quicktron's robotic systems delivered a remarkable 200% surge in production efficiency, while also trimming manufacturing costs by 40%. By seamlessly integrating Quicktron's RCS and Teway's WMS system, numerous robots are orchestrated with precision. This breakthrough not only saved time and costs but also prioritized safety at every stage. The seamless collaboration between the AMR cluster and other automated equipment categories facilitated uninterrupted operations, spanning material inbound/outbound and empty container recycling, ultimately enhancing Teway's production process.

Project Highlights

3000 m²

Automated area

31

M-Series AMRs

Production capacity boosted by **200%**
 Per capita efficiency increased by **600%**
 Labor costs (Receiving process) saved by **90%**
 Payload capacity: **50 Tons/h**
 Unit manufacturing cost decreased by **40%**



Shanghai, China



Realizing the Smart Factory Concept in Pet Food Industry!

Full Pet is a Chinese pet food giant. As one of the top ten pet food enterprises in China, the company has a number of high-end professional pet food production lines service that support more than 300 brands worldwide.

Challenges & Solution

Faced with the need for unmanned handling of substantial payloads and the aspiration to achieve a smart factory paradigm, FULL PET sought a robotic solution that could seamlessly integrate with their current setup, minimize errors, and facilitate pallet transfers.

Quicktron's response was a pallet-handling solution that seamlessly integrated our mobile robots with their existing ASRS system. This innovation efficiently addressed the intricate task of ground handling heavy pallets, achieving an exceptional accuracy rate of 99.99% in transferring them from one point to another. The solution helped them achieve their smart factory goals.

Project Highlights

1000 m²

Automated area

20

M-Series AMRs

Efficiency boosted by **300%**
Accuracy **99.99%**



Pingdingshan, China



The Intelligent Handling Project at the HJT Manufacturing Facility

TW Solar is the world's largest producer of crystalline silicon solar cells, with the highest production capacity and output in the global industry.

Challenges & Solution

TW Solar aimed to elevate intralogistics by seamlessly integrating manufacturing processes with precise equipment positioning.

The project's robots employ cutting-edge technologies, such as SLAM navigation and pure contour positioning, ensuring remarkable precision in final placement. In challenging single-channel settings, the robots achieve a superb handling timeliness rate exceeding 80% and a qualified rate surpassing 99%. They adeptly manage the transportation of silicon wafers between various stages, including rough polishing, fabrication, diffusion, PVD, CVD, and screen printing.

Project Highlights

10,000 m²

Quicktron automated area

29

M-Series AMRs

54

Docking stations

Production Capacity 540,000 pcs/day
Accuracy 99.99%

M5 (X)/(C)



Functions

Driving Mode	Dual Wheel Differential Drive, Spin Rotation, Curve Turning
Navigation	QR Code & Inertial Navigation
Power	Automatic Charging, Manual Charging
Control Mode	Automatic & Manual
Communication	WiFi
Load type	Lifting
HMI	LED Indicators, Control Buttons
Safety	Laser Scanner, Emergency Stop, Safety Edge, CE Certified

Suited Bin

Size 600*400mm (maximum height: 600mm)

Parameters

■ M5(X) ■ M5(C)

Basic	Dimensions	686*492*480mm / 700*498*480mm
	Rotation diameter	752mm / 767mm
	Weight	56kg / 58kg
	Rated load	30kg
	Lift height	370mm
Speed	Unladen	≤ 2m/s
	Laden	before lift ≤1.5m/s after lift ≤1.0 m/s / ≤1.0 m/s
	Lift speed	≤50mm/s
Navigation	Positioning accuracy	±10mm
	Stop angle accuracy	±1°
	QR Code Interval	800*800mm / 850*850mm, support nonuniform interval
Battery	Type	Ternary lithium battery
	Capacity	25.2V /16.5Ah / 25.5V /16.5Ah
	Running time	4h
	Charging time	≤1.5h / ≤1.3h (15A Input, 0-100%)
	Life cycle	500 full cycles
Traffic ability	Traversable gap	20mm
	Allowed step height	≤ 3mm
	Slope angle	≤ 5%
Environment	Ambient temperature	-10-45°C
	Noise	≤75dB

C56 Single deep (X)/(C)



Functions

Driving Mode	Differential drive (2 separate drivetrains) Supports pivoting turning and arc turning
Navigation	QR Code
Power	Automatic recharging; Lithium battery
Control Mode	Automatic & Manual & Remote
Communication	WiFi, 5G (Optional)
Gripper Arm type	Clamping mechanism
HMI	Control Buttons, Light & sound
Safety	Front and back LiDAR, Emergency Stop, Safety Edge, CE Certified

Standard Bin Size

Size (300~650)* (200~500) *(120~400) mm

Parameters

■ C56(X) ■ C56(C)

Basic	Dimensions (L x W x H)	1780*1000*5300 mm (customizable 2-7m)
	Rotation diameter	1950mm
	Weight	~750kg
	Rated load	270kg
	Shelf level height	330mm(min) - 4850mm(max)
	Lift height	320mm(min) - 4950mm(max)
	Rated load (arm / tray)	30/50 kg
	Standard aisle width	1150mm
	Number of carry layers	6 layers (Up to 10)
Speed	Unladen	1.8m/s 1.5m/s
	Laden	1.5m/s
Bin Space	Between column	90mm
	Between row	80mm
Navigation	Stop accuracy	±10mm
	Stop angular accuracy	±1°
Battery	Type	LiMPO4
	Capacity	48V/42 Ah
	Charging time	1.5h
Traffic ability	Life cycle	2000 times
	Gap width	5mm
	Step height	3mm
Environment	Inclination	3%
	Temperature	0°C- 45°C
	Noise	<75dB

Visual Correction

Camera on the gripper is able to recognize deviations through image-processing algorithms. The robot will then adjust its position and the gripper's position accordingly to pick up or drop the bin more accurately.

C56 Double deep

(8.3m)



Functions

Driving Mode	Differential drive (2 separate drivetrains) Supports pivoting turning and arc turning
Navigation	QR Code
Power	Automatic recharging; Lithium battery
Control Mode	Automatic & Manual & Remote
Communication	WiFi, 5G (Optional)
Gripper Arm type	Clamping mechanism
HMI	Control Buttons, Light & sound
Safety	Front and back LiDAR, Emergency Stop, Safety Edge, CE Certified

Standard Bin Size

Size (300~600)* (400~420) *(230~600) mm

Parameters

■ C56(X) ■ C56(C)

Basic	Dimensions	1780*1000*5300 mm (customizable 2-7m)
	Rotation diameter	1950mm / 1980mm
	Weight	~730kg
	Rated load	270kg
	Shelf level height	330mm(min) - 4850mm(max)
	Lift height	320mm(min) - 4950mm(max)
	Rated load (arm / tray)	30 kg
	Standard aisle width	1150mm
	Number of carry layers	6 layers (Up to 10)
Speed	Unladen	1.8m/s / 1.5m/s
	Laden	1.5m/s
Bin Space	Between column	20mm
	Between row	0mm
Navigation	Stop accuracy	±10mm
	Stop angular accuracy	±1°
Battery	Type	LiMPO4
	Capacity	48V/42 Ah
	Charging time	1.5h
	Life cycle	2000 times
Traffic ability	Gap width	5mm
	Step height	3mm
	Inclination	0.03
Environment	Temperature	-10°C - 55°C
	Noise	<75dB

Visual Correction

Camera on the gripper is able to recognize deviations through image-processing algorithms. The robot will then adjust its position and the gripper's position accordingly to pick up or drop the bin more accurately.

M60



Functions

Driving Mode	Differential wheeled; able to perform spinning and U type turning
Navigation	QR Code
Power	Automatic & manual charging
Control Mode	Automatic & Manual
Communication	WiFi
Load type	Lifting beneath rack
HMI	Audio, LED Indicators, Control Buttons, Remote Control
Safety	Laser Scanner, Emergency Stop, Safety Edge, CE Certified

Suited Shelf

900*900*2400mm. Gravity center should be lower than half of shelf height;
max load offset should be less than 1/6 of the shelf length

Parameters

Basic	Dimensions	956*730*240 mm
	Rotation diameter	956mm
	Weight	145kg
	Rated load	600kg
	Lift height	55mm
Speed	Unladen max speed	2.0m/s
	Laden max speed	1.5m/s
Navigation	Positioning accuracy	±10mm
	Stop accuracy	±5mm
	Stop angle accuracy	±1°
	QR Code Interval	1000*1000mm, support nonuniform interval
Battery	Type	Li-NMC
	Capacity	48V/36Ah (optional)
	Running time	9h
	Charging time	< 1.5h (30A)
	Life cycle	500 full cycles
Traffic ability	Traversable gap	≤ 30mm
	Allowed step height	≤ 5mm
	Slope angle	≤5% (2.8°)
Environment	Ambient temperature	0-45°C
	Noise	≤75dB

M100



Functions

Driving Mode	Differential wheeled, able to perform spinning and U type turning
Navigation	QR Code
Power	Automatic & manual charging
Control Mode	Automatic & Manual
Communication	WiFi
Load type	Lifting beneath rack
HMI	Audio, LED Indicators, Control Buttons, Remote Control
Safety	Laser Scanner, Emergency Stop, Safety Edge, CE Certified

Suited Shelf

1200*1200*2400 mm, Gravity center should be lower than half of rack height;
max load offset should be less than 1/6 of the rack length

Parameters

Basic	Dimensions	1182*832*260 mm
	Rotation diameter	1235mm
	Weight	213kg
	Rated load	1000kg
	Lift height	60mm
	Unladen max speed	1.5 m/s
Speed	Laden max speed	1.2m/s
	Positioning accuracy	±10mm
Navigation	Stop accuracy	±5mm
	Stop angle accuracy	±1°
	QR Code Interval	1350*1350mm, support nonuniform interval
Battery	Type	LFP
	Capacity	48V/38.5Ah (optional)
	Running time	7.5 h (under standard operating conditions)
	Charging time	<1.5h(30A)
	Life cycle	1500 times
	Traffic ability	Traversable gap
Allowed step height		≤10mm
Slope angle		≤5%(2.8°)
Environment	Ambient temperature	0- 45°C
	Noise	<75dB

M150



Functions







































Driving Mode	Differential wheeled; able to perform spinning and U type turning
Navigation	QR Code
Power	Automatic & manual charging
Control Mode	Automatic & Manual
Communication	WiFi
Load type	Lifting
HMI	Audio, LED Indicators, Control Buttons, Remote Control
Safety	Laser Scanner, Emergency Stop, Safety Edge, CE Certified

Suited Shelf

1200*1200*2400 mm, Gravity center should be lower than half of rack height;
max load offset should be less than 1/6 of the rack length

Parameters

Basic	Dimensions	1182*832*260 mm
	Rotation diameter	1235mm
	Weight	223kg
	Rated load	1500kg
	Lift height	60mm
	Unladen max speed	1.5 m/s
Speed	Laden max speed	1.2m/s
	Positioning accuracy	±10mm
Navigation	Stop accuracy	±5mm
	Stop angle accuracy	±1°
	QR Code Interval	1350*1350mm, support nonuniform interval
Battery	Type	LFP
	Capacity	48V/38.5Ah (optional)
	Running time	7.5 h (under standard operating conditions)
	Charging time	<1.5h(30A)
	Life cycle	1500 times
Traffic ability	Traversable gap	≤30mm
	Allowed step height	≤10mm
	Slope angle	≤5%(2.8°)
Environment	Ambient temperature	0- 45°C
	Noise	<75dB

Industry	Selected customers				
 E-commerce					
 Manufacturing					
 3PL					
 Electronics					
 Automotive					
 Apparel					
 Retail					

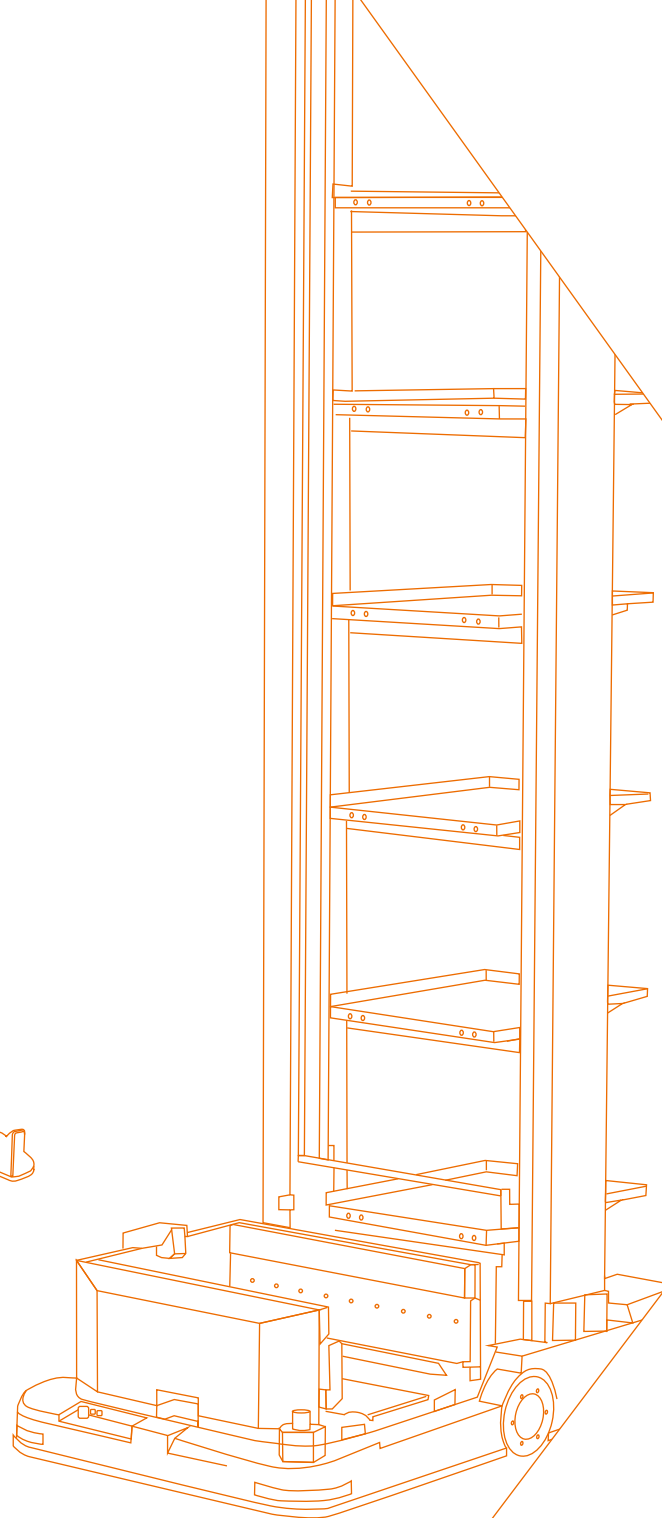
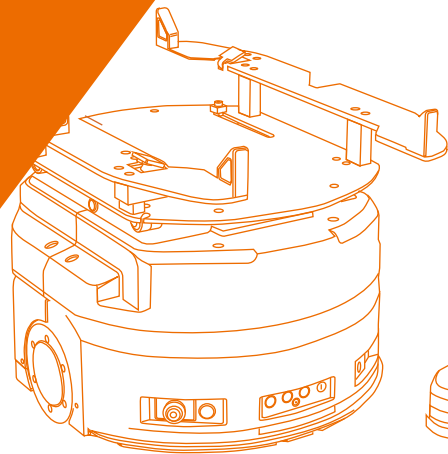

We Move The Future

Shanghai | Frankfurt | Birmingham | Dallas
Tokyo | Seoul | Singapore | Taipei

 Am Kavalleriesand 5, 64295 Darmstadt, Germany